

RoHS Compliant

REV. A/0	DESCRIPTION NEW	DESIGN CWF	DATE
----------	-----------------	------------	------

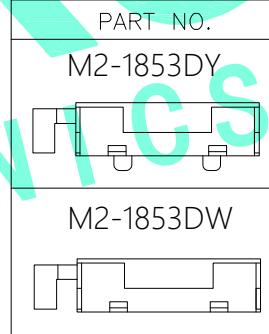

NO.1	
PART NO	vigor
2	130±30
3	160±30
4	250±30

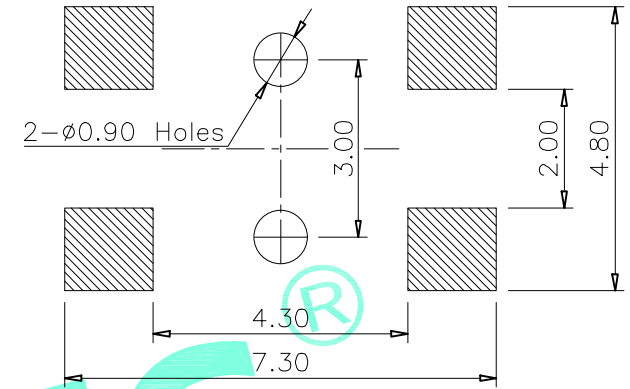
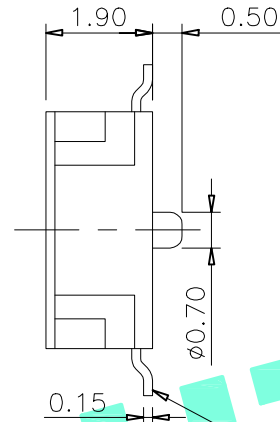
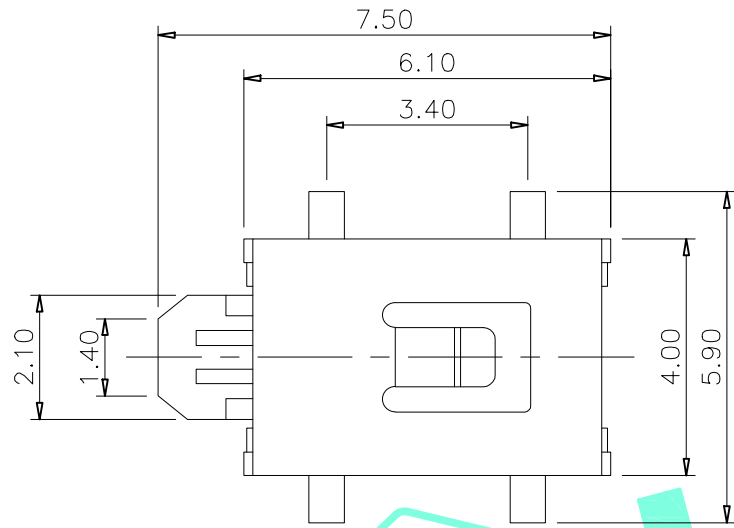
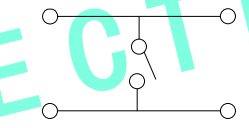
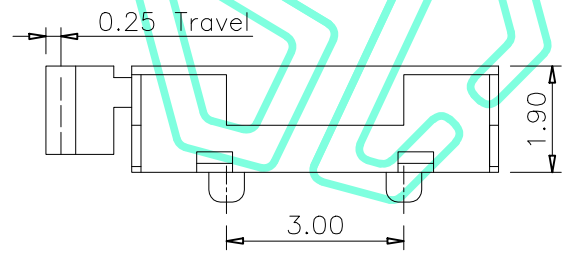

Circuit diagram

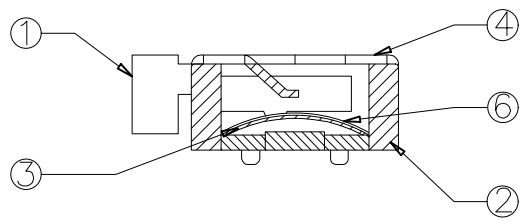

ITEM	PART NAME	QTY.	MATERIAL	FINISHING
⑥	Dust cover	2	Kapton film	Yellow
⑤	Terminal	4	Phosphor Bronze	Ag-PLATED
④	Shell	1	Sheet Iron	Natural
③	Contact	1	Stainless Steel	Ag-PLATED
②	Base	1	LCP	self-colored
①	Keystoke	1	NYLON	Black

THESE DRAWINGS AND SPECIFICATIONS ARE THE PROPERTY OF SHENZHEN YUCHENG ELECTRONICS,LTD.AND SHALL NOT BE REPRODUCED,COPIED OR USED IN ANY MANNER WITHOUT THE PRIOR WRITTEN CONSENT OF SHENZHEN YUCHENG ELECTRONICS,LTD

APPROVED: WEI JIE

CHECKED: HONG JIN YUN

DRAWING: CHEN YA

**UCHENG** 深圳市裕诚电子有限公司  
ELECTRONICS SHENZHEN YUCHENG ELECTRONICS CO.,LTD

GENERAL TOLERANCES	TITLE:	TACT SWITCH		
30~以上 ±0.30	PART NO:	M2-1853D-NO.1		
10~30 ±0.20	WEBSITE:	www.ycelectron.com		
5~10 ±0.15	REV: A	UNIT: mm	SCALE: /	SHEET: A4
~ 5 ±0.10				
SHEET: 1 / 1				