

RoHS Compliant

REV. A/0	DESCRIPTION NEW	DESIGN CWF	DATE
----------	-----------------	------------	------

Waterproof Rating: IPX7

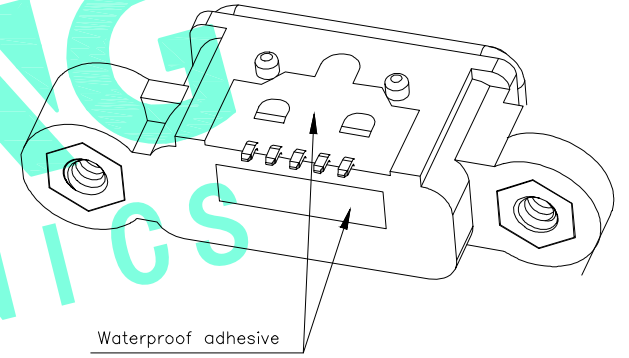
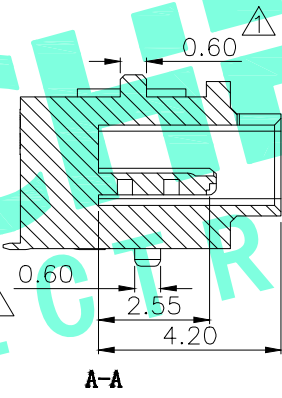
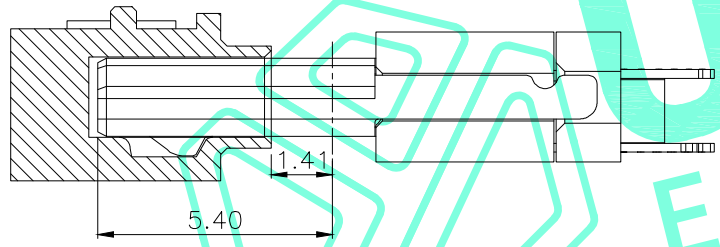
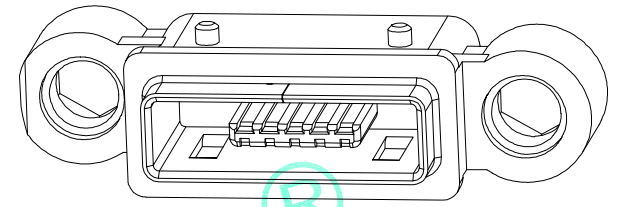
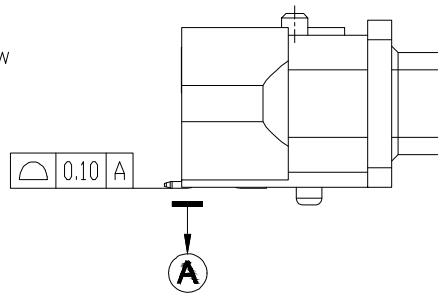
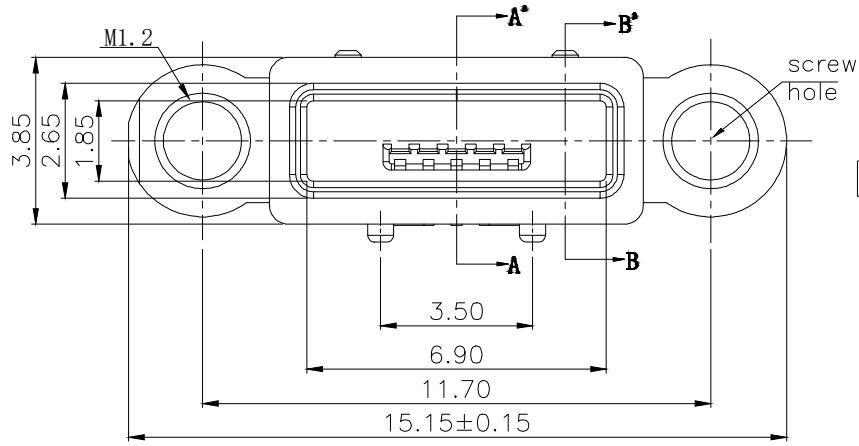

Specifications

1. Rating : DC 30V 0.5A
2. Dielectric withstanding: 100V(AC) for 1min
3. Contact Resistance : 50mΩMax
4. Insulation Resistance: 100MΩ Min
5. Operating Temperature Range: -25 + 80
6. Operating Force : 8-30N
7. Operating Life : 5,000Cycles

③	Shell	1	SUS	Natural
②	Contact	5	Copper Alloy	Au Plated
①	Housing	1	LCP	Black
ITEM	PART NAME	QTY.	MATERIAL	FINISHING

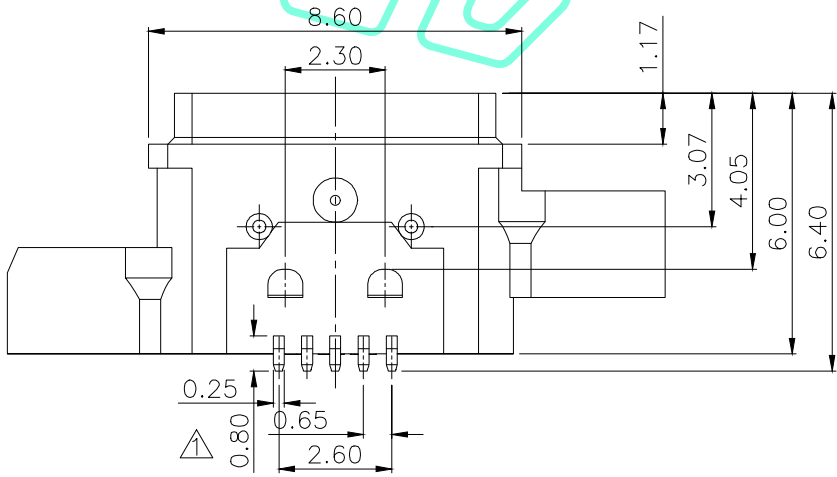

THESE DRAWINGS AND SPECIFICATIONS ARE THE PROPERTY OF SHENZHEN YUCHENG ELECTRONICS, LTD. AND SHALL NOT BE REPRODUCED, COPIED OR USED IN ANY MANNER WITHOUT THE PRIOR WRITTEN CONSENT OF SHENZHEN YUCHENG ELECTRONICS, LTD.



深圳市裕诚电子有限公司
SHENZHEN YUCHENG ELECTRONICS CO.,LTD

APPROVED:	WEI JIE	GENERAL TOLERANCES	TITLE:	防水Micro5PABF板上贴片式SMT锁壳式6.0L
CHECKED:	HONG JIN YUN	30~以上 ±0.30	PART NO:	MICRO-S88E
DRAWING:	CHEN YA	10~30 ±0.25	WEBSITE:	www.ycelectron.com
		5~10 ±0.20	REV: A	UNIT: mm SCALE: / SHEET: A4
		~ 5 ±0.15		
		SHEET: 1 / 1		