

RoHS Compliant

REV. A/0	DESCRIPTION NEW	DESIGN CWF	DATE
----------	-----------------	------------	------

Pin No.	Pin Assignment	Pin No.	Pin Assignment
P1	Micro SD DAT2	P12	GND
P2	Micro SD CD/DAT3	P13	GND
P3	Micro SD CMD	P14	GND
P4	Micro SD VDD1	P15	Micro SD VDD2
P5	Micro SD CLK	P16	Micro SD SWIO
P6	Micro SD VSS	P17	Micro SD VSS
P7	Micro SD DAT0/RCLK+	P18	Micro SD D0+
P8	Micro SD DAT1/RCLK-	P19	Micro SD D0-
P9	Micro SD CD	P20	Micro SD VSS
P10	GND	P21	Micro SD D1-
P11	GND	P22	Micro SD D1+
		P23	Micro SD VSS

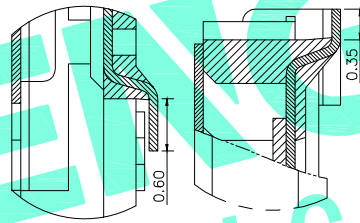
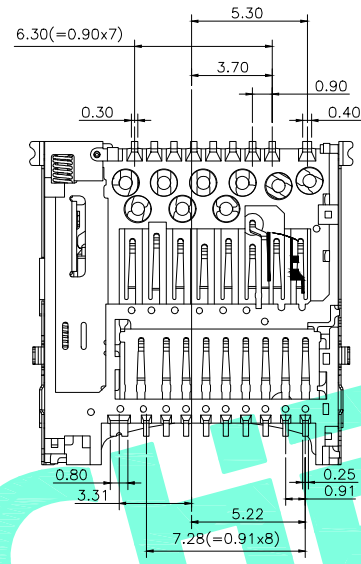
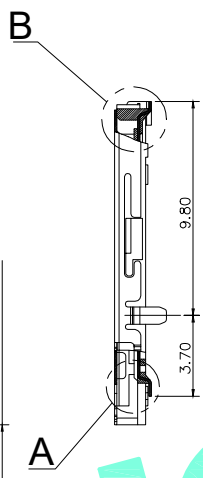
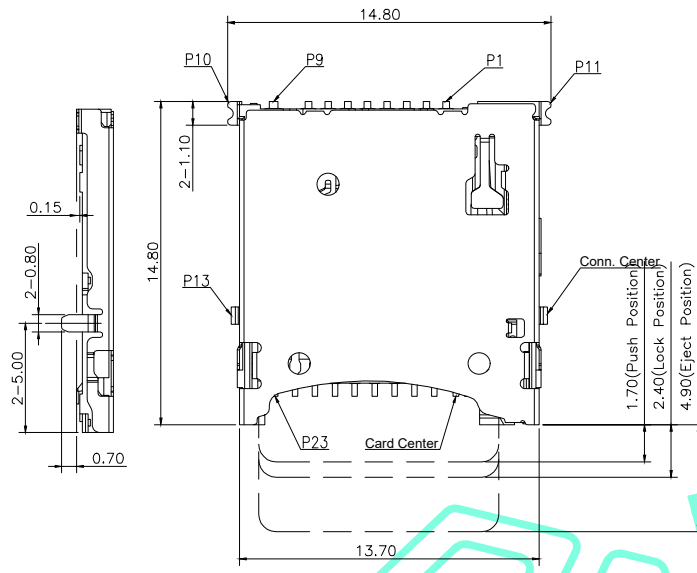

Detail A Scale 4 : 1
Detail B Scale 4 : 1

	Card Detect Switch
Card Uninsertion	Open
Card Half Insertion	Open
Card Insertion	Close

Open Close

P6 P9 P6 P9

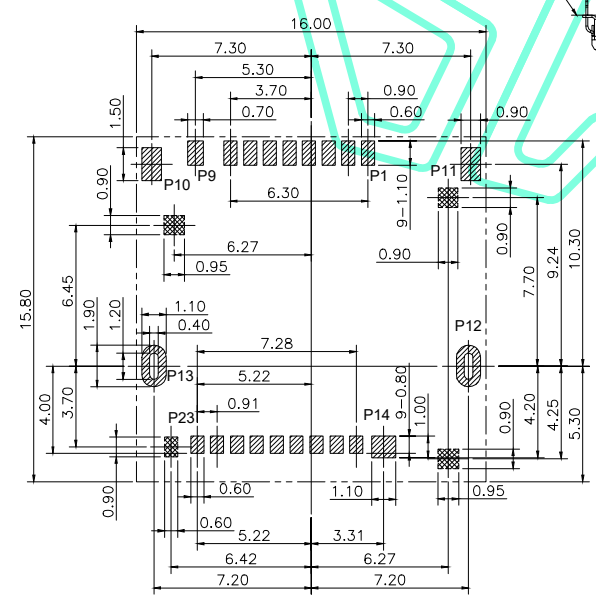
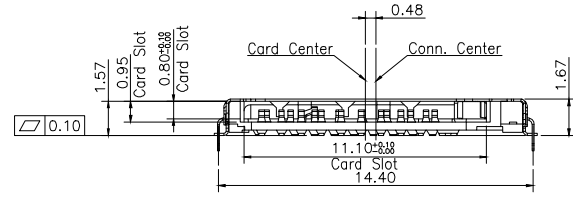
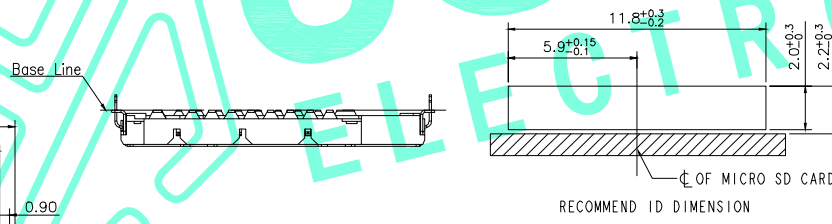

RECOMMENDED P.C.B LAYOUT TOP VIEW(TOLERANCE+/-0.05)

PAD AREA
 NO COMPONENT AREA
 RED GLUING AREA

Specification

- 1 Current Rating :0.5A.
- 2 Voltage Rating :DC 5V
- 3 Ambient Temperature Range : -25°C~+85°C
- 4 Ambient Humidity Range :95% R.H. Max.
- 5 Contact Resistance:100mΩ max.
- 6 Insulation Resistance:1000MΩ min./500VDC
- 7 Durability:5,000 cycles

ITEM	PART NAME	QTY.	MATERIAL	FINISHING
③	Shell	1	SUS	Ni Plated
②	Terminal	20	COPPER ALLOY	Au/Ni Plated
①	Housing	1	LCP	Black

THESE DRAWINGS AND SPECIFICATIONS ARE THE PROPERTY OF SHENZHEN YUCHENG ELECTRONICS, LTD AND SHALL NOT BE REPRODUCED, COPIED OR USED IN ANY MANNER WITHOUT THE PRIOR WRITTEN CONSENT OF SHENZHEN YUCHENG ELECTRONICS, LTD

APPROVED: WEI JIE
CHECKED: HONG JIN YUN
DRAWING: CHEN YA

UCHENG 深圳市裕诚电子有限公司
ELECTRONICS SHENZHEN YUCHENG ELECTRONICS CO.,LTD

GENERAL TOLERANCES
30~以上 ±0.30
10~30 ±0.25
5~10 ±0.20
~ 5 ±0.15

TITLE: TF卡座 Micro SD 4.0 PUSH 外壳前插后贴两排针SMT
PART NO: TF-148Y
WEBSITE: www.ycelectron.com
REV: A UNIT: mm SCALE: / SHEET: A4