

RoHS Compliant

REV. A/0	DESCRIPTION NEW	DESIGN CWF	DATE
-------------	--------------------	---------------	------

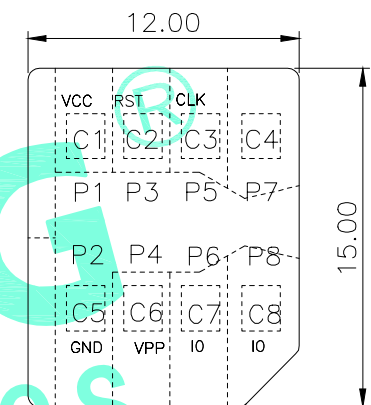
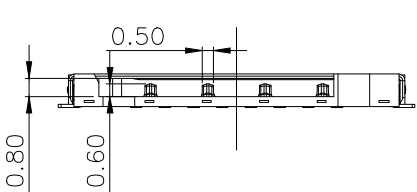
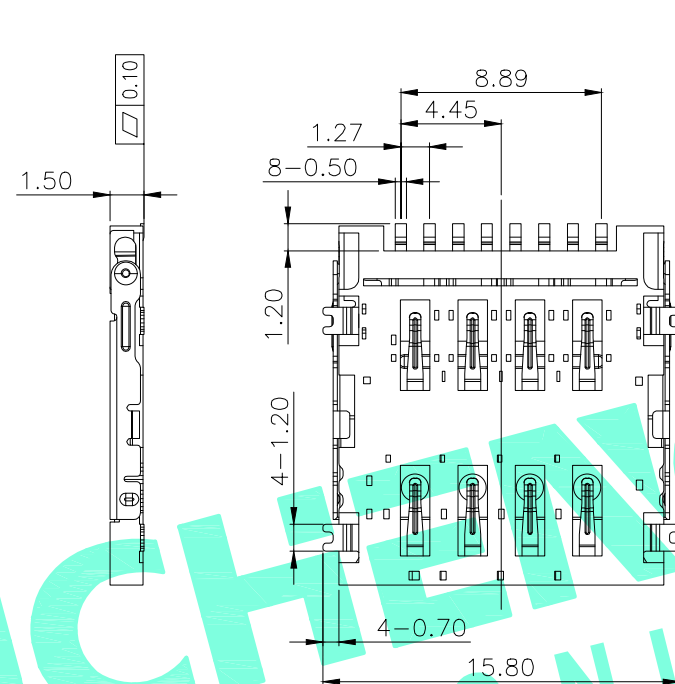
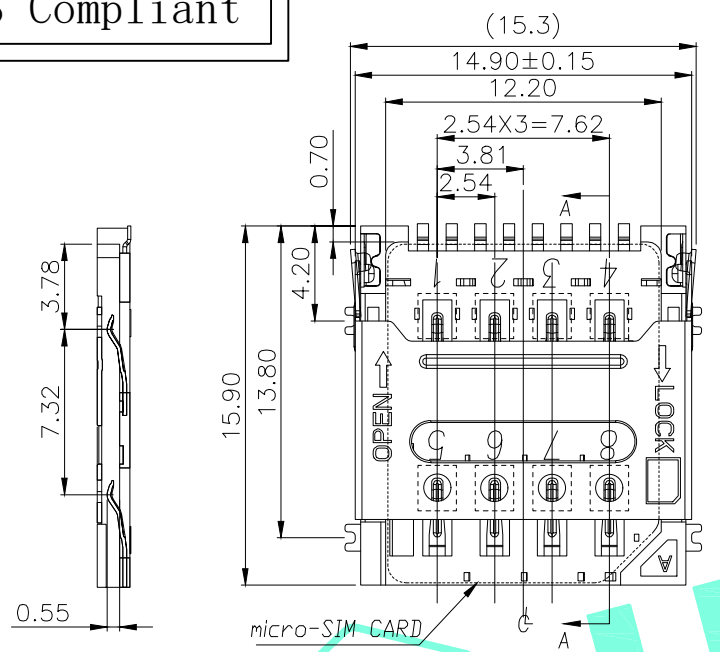

芯片面朝下视图

MICRO SIM CARD	
PIN NO.	DESCRIPTION
P1	C1:VCC
P2	C5:GND
P3	C2:RST
P4	C6:VPP
P5	C3:CLK
P6	C7:I/O
P7	C4:RESERVED
P8	C8:RESERVED

- 1.Current rating: 0.5 A
- 2.Voltage rating: DC 5V
- 3.Dielectric strength:500V AC RMS for 1 minute.
- 4.Contact resistance:100mΩ max.
- 5.Insulator resistance:500MΩ min.at 250V DC.
- 6.Mating unmating cycles:5000 cycles

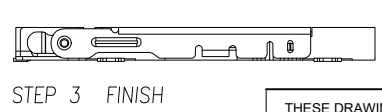
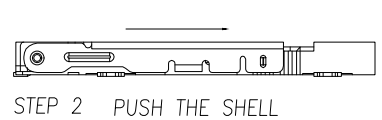
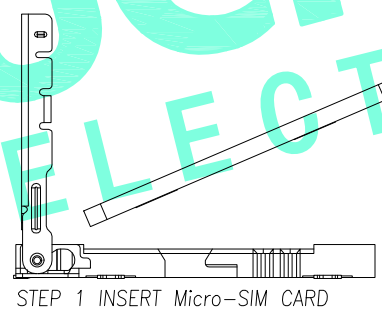
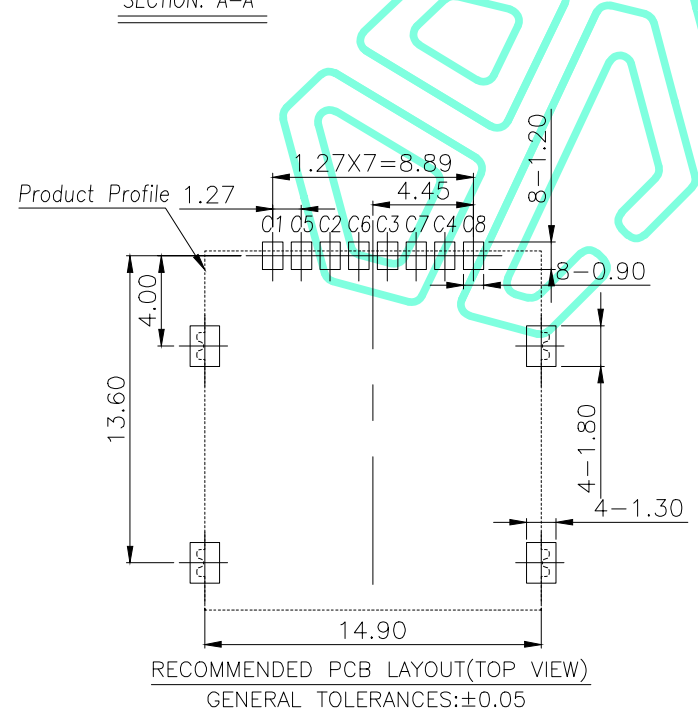

ITEM	PART NAME	QTY.	MATERIAL	FINISHING
⑥	Sliding Block	1	LCP	Black
⑤	Clasp	1	SUS	Ni Plated
④	Spring	1	SUS	Ni Plated
③	Shell	1	SUS	Ni Plated
②	Terminal	6	Phosphor Bronze	Ni/Au Plated
①	Housing	1	LCP	Black

THESE DRAWINGS AND SPECIFICATIONS ARE THE PROPERTY OF SHENZHEN YUCHENG ELECTRONICS,LTD.AND SHALL NOT BE REPRODUCED,COPIED OR USED IN ANY MANNER WITHOUT THE PRIOR WRITTEN CONSENT OF SHENZHEN YUCHENG ELECTRONICS.,LTD

APPROVED: WEI JIE  
 CHECKED: HONG JIN YUN  
 DRAWING: CHEN YA

**UCHENG** 深圳市裕诚电子有限公司  
 ELECTRONICS SHENZHEN YUCHENG ELECTRONICS CO.,LTD

GENERAL TOLERANCES	TITLE: Micro SIM 6Pin贴片SMT式1.5H 掀盖式卡座
30~以上 ±0.30	PART NO: SIM-159Y
10~30 ±0.25	
5~10 ±0.20	WEBSITE: www.ycelectron.com
~ 5 ±0.15	
SHEET: 1 / 1	REV: A UNIT: mm SCALE: / SHEET: A4