

RoHS Compliant

REV. A/0	DESCRIPTION NEW	DESIGN CWF	DATE
-------------	--------------------	---------------	------

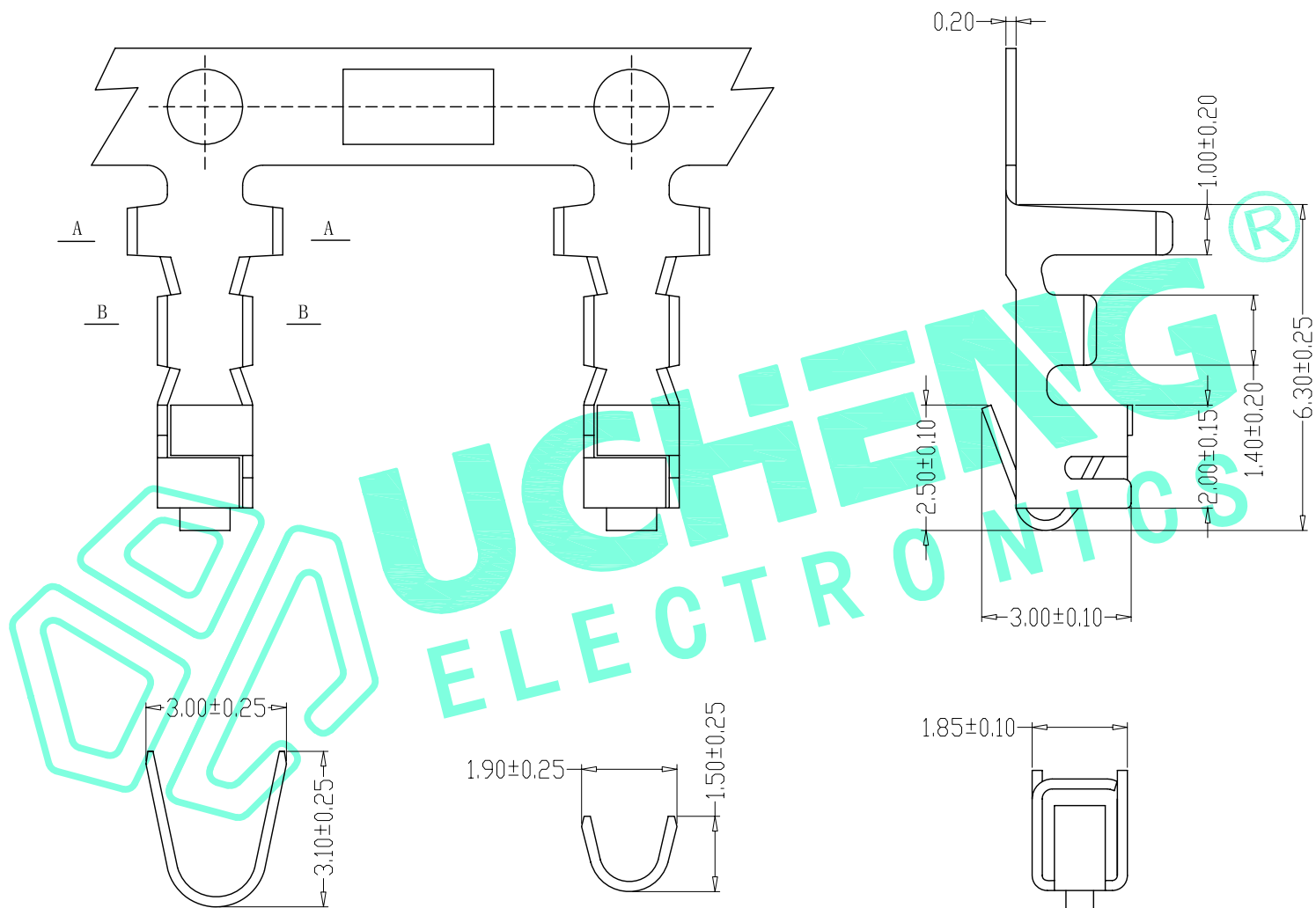

SPECIFICATIONS

1. Current Rating: 3A AC, DC
2. Voltage Rating: 250V AC, DC
3. Temperature Range: -25°C ~ +85°C
4. Contact Resistance: 20mΩ Max
5. Insulation Resistance: 1000MΩ Min
6. Withstanding Voltage: 1000V AC/minute
7. Material: Phosphoric bronze Tin-plated
8. Applicable Wire Sizes: AWG#22~28#

SEC:A-A

SEC:B-B

THESE DRAWINGS AND SPECIFICATIONS ARE THE PROPERTY OF SHENZHEN YUCHENG ELECTRONICS, LTD. AND SHALL NOT BE REPRODUCED, COPIED OR USED IN ANY MANNER WITHOUT THE PRIOR WRITTEN CONSENT OF SHENZHEN YUCHENG ELECTRONICS, LTD.



深圳市裕诚电子有限公司  
SHENZHEN YUCHENG ELECTRONICS CO.,LTD

APPROVED:	WEI JIE
CHECKED:	HONG JIN YUN
DRAWING:	CHEN YA

GENERAL TOLERANCES		TITLE:		TJC3端子	
X:±0.25	X':±2'	PART NO:		A2501-T	
.X:±0.20	.X':±1'	WEBSITE:		www.ycelectron.com	
.XX:±0.15	.XX':±0.5'	REV: A		UNIT: mm	SCALE: /
.XXX:±0.10	.XXX':±0.5'	SHEET: 1 / 1		SHEET: A4	

RoHS Compliant

REV. A/0	DESCRIPTION NEW	DESIGN CWF	DATE
-------------	--------------------	---------------	------

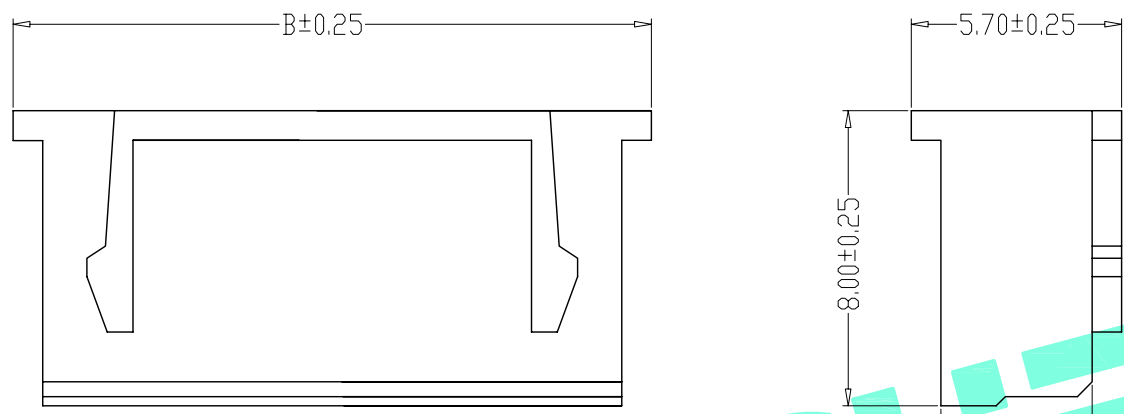

SPECIFICATIONS

- 1、Current Rating: 3A AC, DC
- 2、Voltage Rating: 250V AC, DC
- 3、Temperatuer Range: -25°C ~ +85°C
- 4、Contact Resistance: 20mΩ Max
- 5、Insulation Resistance: 1000 MΩ Min
- 6、Withstanding Voltang: 1000V AC/minute
- 7、Material: Nylon66, UL94V-0

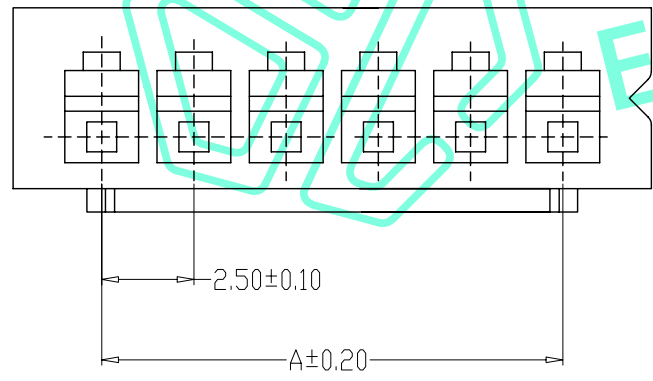

编 号	尺寸 (mm)	
	A	B
A2501-02Y	2.50	7.50
A2501-03Y	5.00	10.00
A2501-04Y	7.50	12.50
A2501-05Y	10.00	15.00
A2501-06Y	12.50	17.50
A2501-07Y	15.00	20.00
A2501-08Y	17.50	22.50
A2501-09Y	20.00	25.00
A2501-10Y	22.50	27.50
A2501-11Y	25.00	30.00
A2501-12Y	27.50	32.50
A2501-20Y	47.50	52.50

THESE DRAWINGS AND SPECIFICATIONS ARE THE PROPERTY OF SHENZHEN YUCHENG ELECTRONICS.,LTD.AND SHALL NOT BE REPRODUCED,COPIED OR USED IN ANY MANNER WITHOUT THE PRIOR WRITTEN CONSENT OF SHENZHEN YUCHENG ELECTRONICS.,LTD

APPROVED: WEI JIE

CHECKED: HONG JIN YUN

DRAWING: CHEN YA



深圳市裕诚电子有限公司  
SHENZHEN YUCHENG ELECTRONICS CO.,LTD

GENERAL TOLERANCES		TITLE:		TJC3孔座	
X:±0.25	X':±2'	PART NO:		A2501-NY	
.X±0.20	.X'±1'	WEBSITE:		www.ycelectron.com	
.XX±0.15	.XX'±0.5'	REV: A		UNIT: mm	SCALE: /
.XXX±0.10	.XXX'±0.5'	SHEET: 1 / 1		SHEET: A4	☉

RoHS Compliant

REV. A/0	DESCRIPTION NEW	DESIGN CWF	DATE
-------------	--------------------	---------------	------

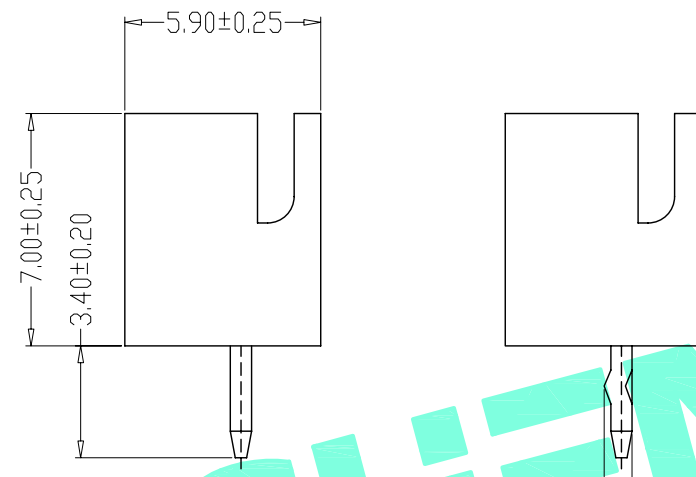
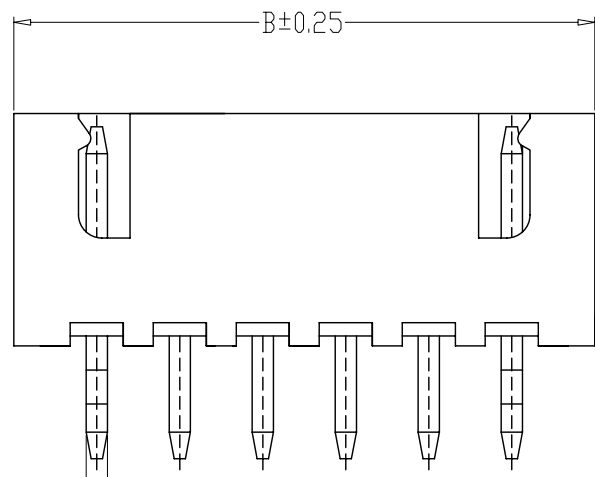

- SPECIFICATIONS
- 1、Current Rating: 3A AC, DC
  - 2、Voltage Rating: 250V AC, DC
  - 3、Temperatuer Range: -25℃~+85℃
  - 4、Contact Resistance: 20mΩ Max
  - 5、Insulation Resistance: 1000MΩ Min
  - 6、Withstanding Voltang: 1000V AC/minute
  - 7、Material: Wafer Nylon66, UL94V-0  
PIN Brass Tin-plated

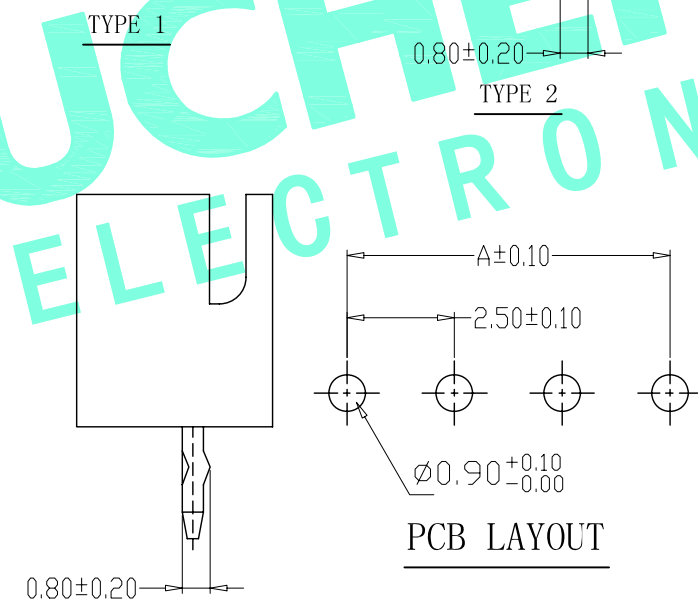
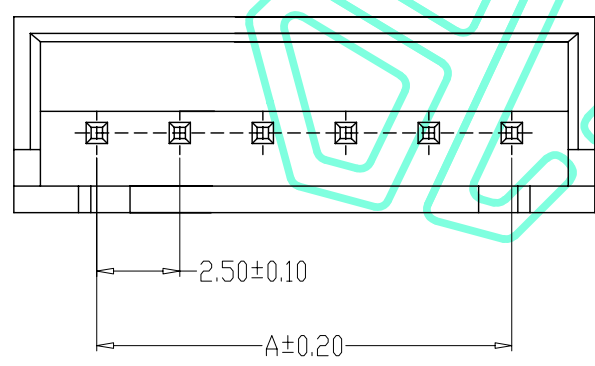

编号	尺寸 (mm)	
	A	B
A2501-02A	2.50	7.50
A2501-03A	5.00	10.00
A2501-04A	7.50	12.50
A2501-05A	10.00	15.00
A2501-06A	12.50	17.50
A2501-07A	15.00	20.00
A2501-08A	17.50	22.50
A2501-09A	20.00	25.00
A2501-10A	22.50	27.50
A2501-11A	25.00	30.00
A2501-12A	27.50	32.50
A2501-20A	47.50	52.50

THESE DRAWINGS AND SPECIFICATIONS ARE THE PROPERTY OF SHENZHEN YUCHENG ELECTRONICS.,LTD.AND SHALL NOT BE REPRODUCED,COPIED OR USED IN ANY MANNER WITHOUT THE PRIOR WRITTEN CONSENT OF SHENZHEN YUCHENG ELECTRONICS.,LTD

APPROVED: WEI JIE  
CHECKED: HONG JIN YUN  
DRAWING: CHEN YA

**UCHENG** ELECTRONICS 深圳市裕诚电子有限公司  
SHENZHEN YUCHENG ELECTRONICS CO.,LTD

GENERAL TOLERANCES	TITLE:	TJC3直针 WAFER DIP TYPE
X:±0.25 X':±2'	PART NO:	A2501-NA
.X:±0.20 .X':±1'	WEBSITE:	www.ycelectron.com
.XX:±0.15 .XX':±0.5'	REV: A	UNIT: mm SCALE: / SHEET: A4
.XXX:±0.10 .XXX':±0.5'	SHEET: 1 / 1	

RoHS Compliant

REV. A/0	DESCRIPTION NEW	DESIGN CWF	DATE
-------------	--------------------	---------------	------

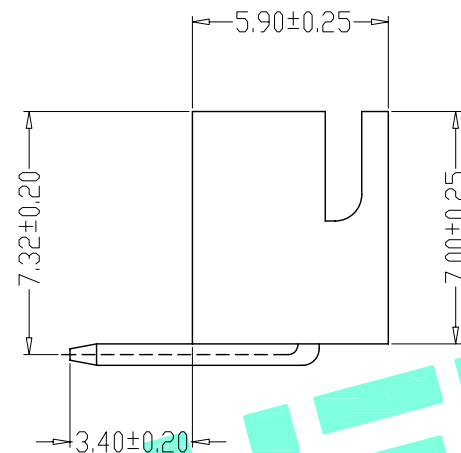
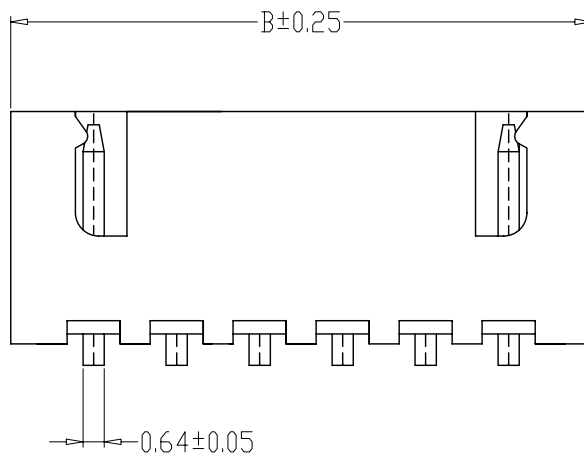

SPECIFICATIONS

- 1、Current Rating: 3A AC, DC
- 2、Voltage Rating: 250V AC, DC
- 3、Temperature Range:  $-25^{\circ}\text{C} \sim +85^{\circ}\text{C}$
- 4、Contact Resistance:  $20\text{m}\Omega$  Max
- 5、Insulation Resistance:  $1000\text{M}\Omega$  Min
- 6、Withstanding Voltage:  $1000\text{V AC/minute}$
- 7、Material: Wafer Nylon66, UL94V-0  
PIN Brass Tin-plated

TYPE 1

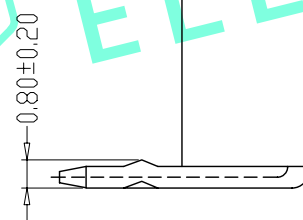
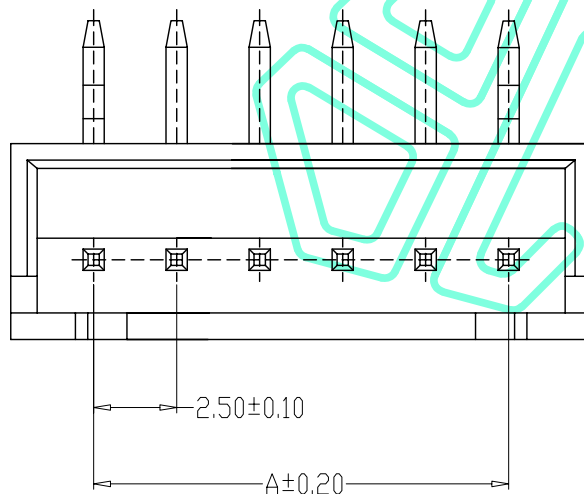

TYPE 2

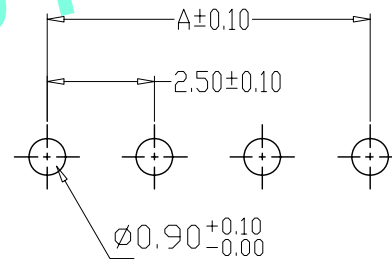

PCB LAYOUT

编号	尺寸 (mm)	
	A	B
A2501-02AW	2.50	7.50
A2501-03AW	5.00	10.00
A2501-04AW	7.50	12.50
A2501-05AW	10.00	15.00
A2501-06AW	12.50	17.50
A2501-07AW	15.00	20.00
A2501-08AW	17.50	22.50
A2501-09AW	20.00	25.00
A2501-10AW	22.50	27.50
A2501-11AW	25.00	30.00
A2501-12AW	27.50	32.50
A2501-20AW	47.50	52.50

THESE DRAWINGS AND SPECIFICATIONS ARE THE PROPERTY OF SHENZHEN YUCHENG ELECTRONICS, LTD. AND SHALL NOT BE REPRODUCED, COPIED OR USED IN ANY MANNER WITHOUT THE PRIOR WRITTEN CONSENT OF SHENZHEN YUCHENG ELECTRONICS, LTD.



深圳市裕诚电子有限公司  
SHENZHEN YUCHENG ELECTRONICS CO.,LTD

APPROVED: WEI JIE  
CHECKED: HONG JIN YUN  
DRAWING: CHEN YA

GENERAL TOLERANCES	
X:±0.25	X:±2°
.X:±0.20	.X:±1°
.XX:±0.15	.XX:±0.5°
.XXX:±0.10	.XXX:±0.5°

TITLE:	TJC3弯针 WAFER DIP TYPE		
PART NO:	A2501-NAW		
WEBSITE:	www.ycelectron.com		
REV: A	UNIT: mm	SCALE: /	SHEET: A4

SHEET: 1 / 1

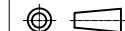

RoHS Compliant

REV. A/0	DESCRIPTION NEW	DESIGN CWF	DATE
----------	-----------------	------------	------

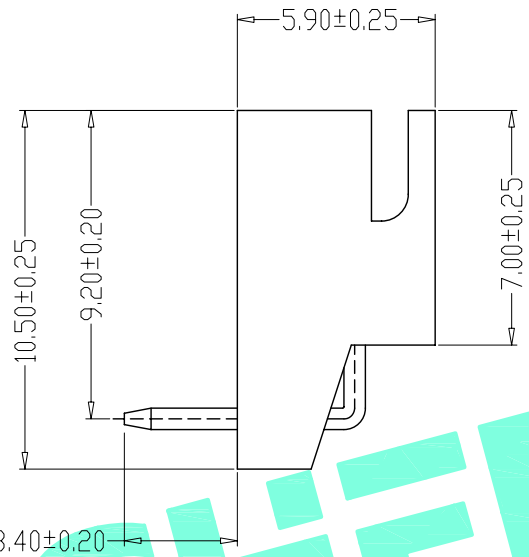
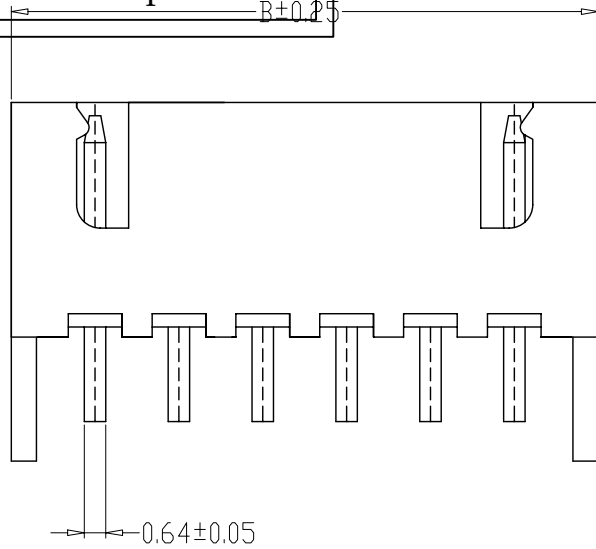

- SPECIFICATIONS**
- 1、Current Rating: 3A AC, DC
  - 2、Voltage Rating: 250V AC, DC
  - 3、Temperatuer Range: -25℃~+85℃
  - 4、Contact Resistance: 20mΩ Max
  - 5、Insulation Resistance: 1000MΩ Min
  - 6、Withstanding Voltang: 1000V AC/minute
  - 7、Material: Wafer Nylon66, UL94V-0  
PIN Brass Tin-plated

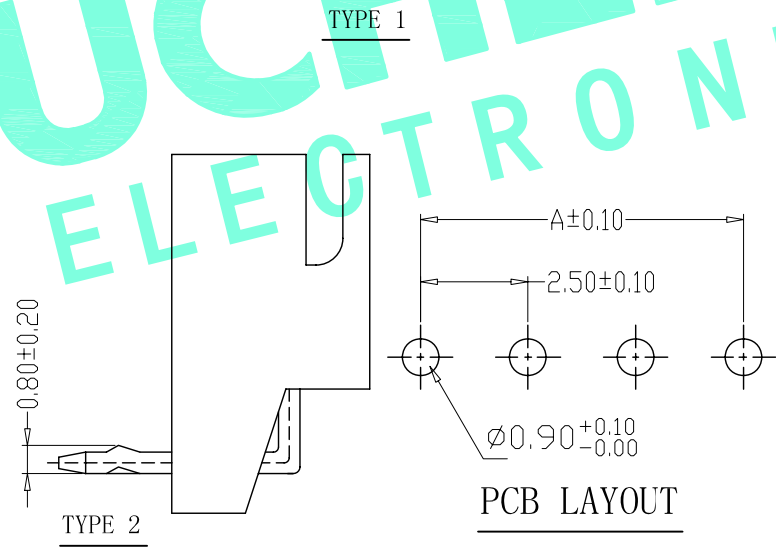
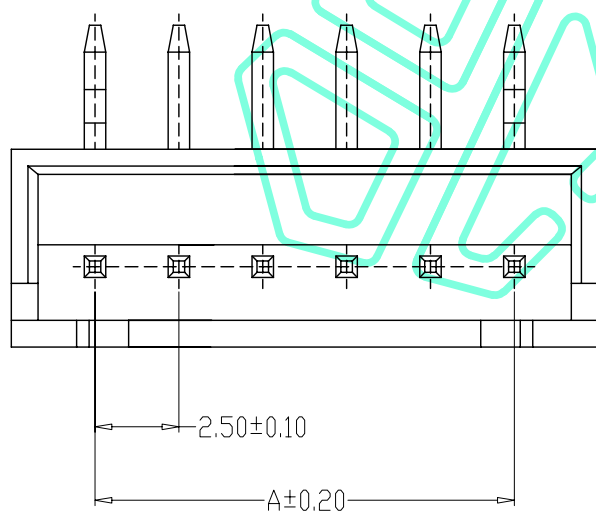

编 号	尺寸 (mm)	
	A	B
A2501-02AWD	2.50	7.50
A2501-03AWD	5.00	10.00
A2501-04AWD	7.50	12.50
A2501-05AWD	10.00	15.00
A2501-06AWD	12.50	17.50
A2501-07AWD	15.00	20.00
A2501-08AWD	17.50	22.50
A2501-09AWD	20.00	25.00
A2501-10AWD	22.50	27.50
A2501-11AWD	25.00	30.00
A2501-12AWD	27.50	32.50
A2501-20AWD	47.50	52.50

THESE DRAWINGS AND SPECIFICATIONS ARE THE PROPERTY OF SHENZHEN YUCHENG ELECTRONICS, LTD. AND SHALL NOT BE REPRODUCED, COPIED OR USED IN ANY MANNER WITHOUT THE PRIOR WRITTEN CONSENT OF SHENZHEN YUCHENG ELECTRONICS, LTD.

APPROVED: WEI JIE  
 CHECKED: HONG JIN YUN  
 DRAWING: CHEN YA

**UCHENG** ELECTRONICS 深圳市裕诚电子有限公司  
 SHENZHEN YUCHENG ELECTRONICS CO.,LTD

GENERAL TOLERANCES		TITLE: TJC3定位弯针 WAFER DIP TYPE	
X±0.25	X*±2°	PART NO:	A2501-NAWD
.X±0.20	.X*±1°	WEBSITE:	www.ycelectron.com
.XX±0.15	.XX*±0.5°	REV: A	UNIT: mm
.XXX±0.10	.XXX*±0.5°	SHEET: 1 / 1	SCALE: /
		SHEET: A4	DATE: / /